

User Manual

neonavia[®]

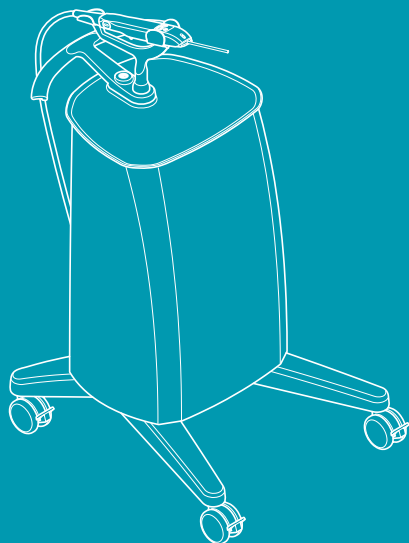

Table of contents

1	Introduction.....	2
1.1	About this manual.....	2
1.2	Indications for use.....	2
1.3	Contraindications.....	2
1.4	Potential complications.....	2
1.5	Contact information.....	3
2	Safety information.....	4
2.1	Safety definitions.....	4
2.2	Warnings.....	4
2.3	Cautions.....	5
2.4	Symbols on the product.....	5
3	Product overview.....	10
3.1	Included in the delivery.....	10
3.2	Base unit – overview.....	10
3.3	Driver – overview.....	11
3.4	Probes – overview.....	11
3.5	Product description.....	12
4	Installation.....	13
4.1	Site requirements.....	13
4.2	Power requirements.....	13
4.3	To install NeoNavia biopsy system.....	13
5	Operation.....	16
5.1	To prepare for biopsy.....	16
5.2	To perform a biopsy.....	17
5.3	To turn off the NeoNavia® biopsy system and dispose of the probe after biopsy.....	24
6	Maintenance.....	25
6.1	To clean and inspect.....	25
6.2	To do an electrical safety test.....	27
6.3	To maintain the driver.....	28
7	Troubleshooting.....	29
7.1	To troubleshoot NeoNavia® biopsy system.....	29
7.2	To troubleshoot the driver.....	35
7.3	To troubleshoot the probe.....	35
8	Recycling.....	37
8.1	To recycle the NeoNavia® biopsy system.....	37
9	Technical data.....	38
9.1	Conformity.....	38
9.2	Weight and dimensions.....	38
9.3	Electrical specifications.....	38
9.4	Electromagnetic compatibility (EMC).....	38
10	Consumables.....	43

1 Introduction

This document shows the necessary information to operate NeoNavia® biopsy system.



Notice: Federal law restricts this device to sale by or on the order of a physician.

1.1 About this manual

This NeoNavia® user manual gives you the instructions you need to safely:

- install
- operate, or
- do maintenance on the system.

Keep this manual for future reference.



Notice: Use NeoNavia® only as directed in this manual. All use, other than that described in this manual, is seen as unintended use. Do not modify NeoNavia®. Unauthorized modifications void the warranty.

1.2 Indications for use

The NeoNavia® biopsy system is intended for obtaining tissue samples from both breast lesions and axillary lymph nodes for diagnostic analysis of breast abnormalities.

The FlexiPulse™ and VacuPulse™ probes are intended to provide tissue samples from breast lesions and axillary lymph nodes for histologic examination.

The NeoNavia® biopsy system is to be used only by healthcare professionals in hospitals or healthcare facilities.

1.3 Contraindications

NeoNavia® is for diagnostic use only and is not indicated for therapeutic use.

NeoNavia® is contraindicated for those patients where increased risk of complications may be associated with percutaneous removal of tissue samples upon the physician's judgment. Patients receiving anticoagulant therapy or who may have bleeding disorders may be at increased risk.

1.4 Potential complications

Potential complications are those associated with any percutaneous removal/biopsy technique for tissue collection.

Potential complications are limited to the region surrounding the biopsy site and include hematoma, hemorrhage, infection, pain, and tissue adherence to the biopsy needle while removing it from the breast or axilla.

1.5 Contact information



Contact us at:	Information
Manufacturer Address NeoDynamics AB Lejonvägen 14 SE-181 32 Lidingö Sweden	Send a letter to note your specific area of interest. Please include your customer name and account number, your contact information and your question.
Phone Sweden +46(0)8 522 79661	Contact a customer service representative between the hours 9:00 – 16:00 CET. Please have your customer name and account number ready so that a member of our customer service team can assist you as quickly and efficiently as possible.
Phone US 1-800-912-9802	Contact a customer service representative between the hours 9:00 – 18:00 EST. Please have your customer name and account number ready so that a member of our customer service team can assist you as quickly and efficiently as possible.
Email uscustomerservice@neodynamics.com	Send an email to note your specific area of interest to our customer service team. Please include your customer name and account number, your contact information and your question. A member of our customer service team will contact you within 24 hours.
Website www.neodynamics.com	Complete the <i>Contact Us</i> form on the NeoDynamics website. A member of our customer service team will contact you within 24 hours.

2 Safety information

This chapter contains the safety information. Before you install, operate or do maintenance on the system, you must know the safety information given in this manual. Follow the instructions in this manual to prevent injuries or damage to the equipment. If a serious incident that involves NeoNavia® biopsy system occurs, contact NeoDynamics AB and the competent authority of your country.

2.1 Safety definitions

This user manual contains WARNINGS, CAUTIONS and NOTICES that are applicable for the safe operation of the NeoNavia® biopsy system.

	<p>WARNING means that injury or death is possible if the instructions are not followed.</p>
	<p>CAUTION means that damage to equipment is possible if the instructions are not followed.</p>
	<p>NOTICE means that the information is important for trouble-free and optimal use of the device.</p>

2.2 Warnings

- Do not make changes to the NeoNavia® biopsy system, except for changes given in the user documentation, without authorization from the manufacturer.
- Do not use the NeoNavia® biopsy system near active HF surgical equipment.
- Do not use the NeoNavia® near the RF shielded room of a system for magnetic resonance imaging (MRI)
- Do not use components or accessories that are not supplied or recommended by NeoDynamics AB. Using improper accessories may result in increased electromagnetic emissions or decreased electromagnetic immunity of the NeoNavia® biopsy system and lead to improper operation.
- Use of the NeoNavia® biopsy system adjacent to or stacked with other equipment, for example ultrasound equipment, should be avoided. It can result in improper operation. If such use is necessary, the NeoNavia® biopsy system and the other equipment should be observed to verify that they are operating normally.
- Portable and mobile RF communication equipment (including peripherals such as antenna cables and external antennas) should not be used closer than 30 cm to any part of the NeoNavia® biopsy system, including cables specified by the manufacturer. Otherwise, degradation of the performance of this equipment could result.
- Only connect NeoNavia® to a supply mains with protective earth. Risk of electrical shock.
- Do not use a multiple socket-outlet or an extension cord.
- Use ultrasound guidance when you operate NeoNavia®, to visualize the movements of the device. Do not use MRI or stereotactic guidance. The NeoNavia® is MR unsafe.
- Do not re-sterilize NeoNavia® biopsy probes. They are intended for single patient use only. The use of re-sterilized components, intended for single patient use only, can result in infection or injury of the patient.
- Do not use NeoNavia® biopsy probes more than once. They are intended for single patient use only. If components that are intended for single patient use only are used again, it can result in infection or injury of the patient.



- Do not use NeoNavia® biopsy probes if the sterile package is broken or damaged or if the Use by date has passed.
- Do not use NeoNavia® biopsy probes if any part of the device that is intended for patient contact has been in contact with a non-sterile surface. If this is the case, NeoNavia® biopsy probe must be disposed of according to the instructions in this manual.
- Do not permanently bend or deform the sampling needle. If the sampling needle is bent, do not use the probe.
- Do not use a damaged probe. Discard the probe as referred to in local laws and regulations.
- Use applicable personal protective equipment following local guidelines (for example gloves), during operation and maintenance of NeoNavia®, to prevent exposure to biohazards.
- Before using NeoNavia® adjacent to ultrasound equipment, make sure to verify normal operation by following the instructions in 5.1.
- Make sure that the driver cable is secure when moving NeoNavia®. A loose cable can trip the operator.
- Do not submerge or spray liquids directly on any parts of the NeoNavia® biopsy system.













2.3 Cautions

- Do not transport NeoNavia® outside of normal hospital conditions, e.g. outdoors or to a different facility.
- Do not use NeoNavia® when the power cord is wound around the cover, handle or any other part of the base unit.
- Do not sit on the tray or the handle of the base unit. This might damage or break the base unit. It can also overturn the base unit and lead to operator injury.
- Only use NeoNavia® when the driver cable is free from external pressure. Objects or persons standing on the cable may lead to reduced performance and damage to the cable.
- Floors should be wood, concrete or ceramic tile. If floors are covered with synthetic material, see 9.4.2 for more information.
- Do not manually manipulate the probe before attaching it to the driver. The probe might become unusable.













2.4 Symbols on the product















2.4.1 Symbols on the devices



Symbol	Description	Where
	Complies with EU Directive 93/42/EEC on medical devices.	<ul style="list-style-type: none"> • Driver
	Federal law restricts this device to sale by or on the order of a physician.	<ul style="list-style-type: none"> • Base unit • Driver
	MR unsafe	<ul style="list-style-type: none"> • Base unit • Driver

Symbol	Description	Where
 <p>ETL CLASSIFIED ETL C-UL US Intertek</p>	ETL classified mark	<ul style="list-style-type: none"> • Base unit • Driver
	Follow instructions for use	<ul style="list-style-type: none"> • Base unit • Driver
	Manufacturer	<ul style="list-style-type: none"> • Base unit • Driver
	Serial number	<ul style="list-style-type: none"> • Base unit • Driver
	Electronic waste, disposal according to WEEE	<ul style="list-style-type: none"> • Driver
	Ground/Earth	<ul style="list-style-type: none"> • Base unit
	Type BF Applied part	<ul style="list-style-type: none"> • Base unit
	Stand-by	<ul style="list-style-type: none"> • Base unit
	Light symbol	<ul style="list-style-type: none"> • Driver
	Pulse symbol	<ul style="list-style-type: none"> • Driver
	Sampling symbol	<ul style="list-style-type: none"> • Driver
	Caution	<ul style="list-style-type: none"> • Probes
	Do not reuse	<ul style="list-style-type: none"> • Probes

2.4.2 Symbols on the packaging

Symbol	Description	Where
	Complies with EU Directive 93/42/EEC on medical devices	<ul style="list-style-type: none"> • Driver • Probes
	Federal law restricts this device to sale by or on the order of a physician.	<ul style="list-style-type: none"> • Base unit • Driver • Probes
	MR unsafe	<ul style="list-style-type: none"> • Probes
	Medical Device	<ul style="list-style-type: none"> • Base unit • Driver • Probes
	Consult operating instructions	<ul style="list-style-type: none"> • Base unit • Driver • Probes
	Manufacturer	<ul style="list-style-type: none"> • Base unit • Driver • Probes
	Catalogue number (Reference or model number)	<ul style="list-style-type: none"> • Base unit • Driver • Probes
	Unique Device Identifier	<ul style="list-style-type: none"> • Base unit • Driver • Probes
	Fragile, handle with care	<ul style="list-style-type: none"> • Base unit • Driver • Probes
	Keep dry	<ul style="list-style-type: none"> • Base unit • Driver • Probes
	Temperature limits	<ul style="list-style-type: none"> • Base unit • Driver • Probes
	Humidity range	<ul style="list-style-type: none"> • Base unit • Driver • Probes
	Atmospheric pressure range	<ul style="list-style-type: none"> • Base unit • Driver • Probes

Symbol	Description	Where
	Producers' responsibility for packaging	<ul style="list-style-type: none"> • Driver • Probes
	Serial number	<ul style="list-style-type: none"> • Base unit • Driver
	Electronic waste, disposal according to WEEE	<ul style="list-style-type: none"> • Driver
	This way up	<ul style="list-style-type: none"> • Base unit
	Follow the instructions for use	<ul style="list-style-type: none"> • Probes
	Quantity of products included in the box	<ul style="list-style-type: none"> • Probes
	Lot number	<ul style="list-style-type: none"> • Probes
	Do not use if damaged	<ul style="list-style-type: none"> • Probes
	Refer to the NeoNavia® biopsy system user manual	<ul style="list-style-type: none"> • Probes
	The sterile package contains 1 probe (REF# 2102 or 2104)	<ul style="list-style-type: none"> • Probes
	Sterilized using ethylene oxide	<ul style="list-style-type: none"> • Probes
	The number of sterile tissue baskets in the package.	<ul style="list-style-type: none"> • Accessory
	Use by date (YYYY-MM)	<ul style="list-style-type: none"> • Probes
	Do not reuse	<ul style="list-style-type: none"> • Probes

Symbol	Description	Where
	Contains FlexiPulse probe	<ul style="list-style-type: none">• Probes
	Contains VacuPulse probe	<ul style="list-style-type: none">• Probes

3 Product overview

3.1 Included in the delivery

Base unit delivery

The items in the list below are included in the delivery of the base unit, REF# 1102:

- 1 Base unit
- 1 Holder
- 1 Power cord (length: 3 m / 9.8 ft)
- 1 NeoNavia® biopsy system user manual

Driver delivery

The items in the list below are included in the delivery of the driver, REF# 1103:

- 1 Driver

Probe shipping box

The items in the list below are included in the delivery of the probes, FlexiPulse REF# 2104, VacuPulse REF# 2102.

- 2 product boxes. Each product box contains 5 probes.

3.2 Base unit – overview

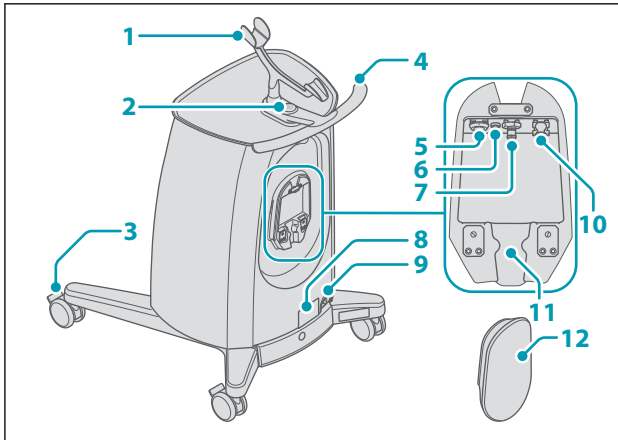

- | | |
|---------------------------------------|-------------------------------|
| 1. Holder for the driver | 7. Vacuum connector |
| 2. On/Off button and status indicator | 8. Machine plate |
| 3. Wheel with locking mechanism | 9. Mains power connector |
| 4. Handle | 10. Pressurized air connector |
| 5. Electrical connector | 11. Cable holder |
| 6. Ground connection | 12. Cover |

3.3 Driver – overview

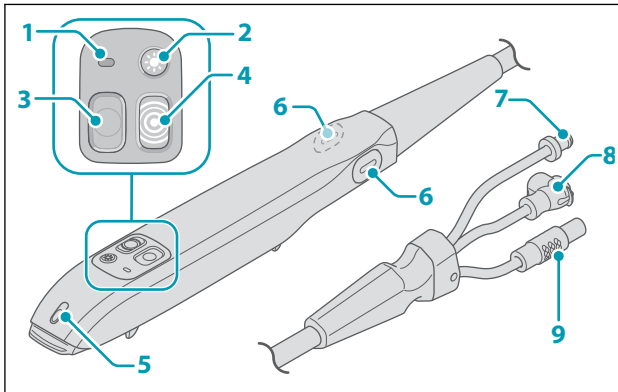

- | | |
|----------------------------|------------------------------|
| 1. Driver status indicator | 6. Release buttons |
| 2. Light button | 7. Pressurized air connector |
| 3. Sampling button | 8. Vacuum connector |
| 4. Pulse button | 9. Electrical connector |
| 5. Light | |

3.4 Probes – overview

3.4.1 FlexiPulse – overview

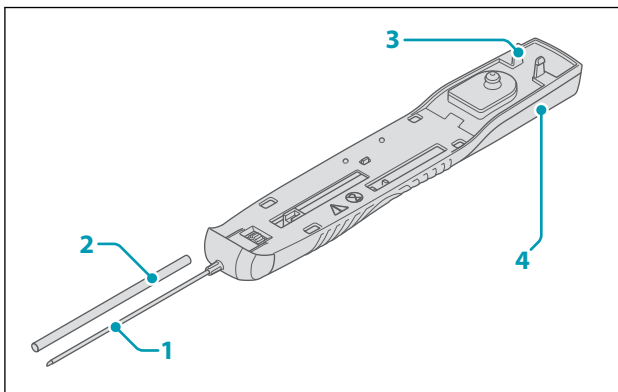

- | | |
|----------------------|-------------------|
| 1. Sampling needle | 3. Fastener |
| 2. Protective sleeve | 4. Vacuum chamber |

3.4.2 VacuPulse – overview

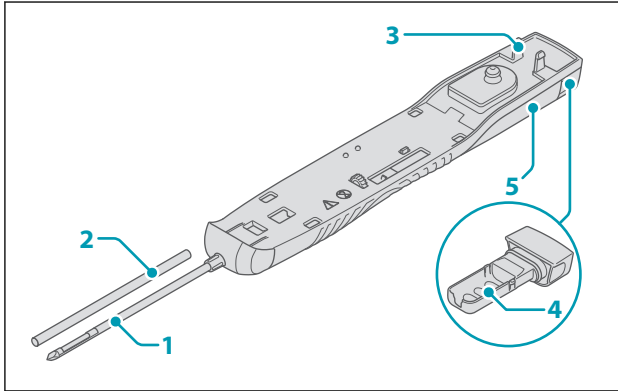

- | | |
|----------------------|-------------------|
| 1. Sampling needle | 4. Tissue basket |
| 2. Protective sleeve | 5. Vacuum chamber |
| 3. Fastener | |

3.5 Product description

NeoNavia® biopsy system incorporates pulse technology and is designed to obtain tissue samples from breast lesions or axillary lymph nodes for histological evaluation. The system is composed of a base unit, a driver and two different types of sterile single use probes. Each needle type utilizes pulses with the intention to improve precision and control when inserting and positioning the biopsy needle in a suspicious lesion. NeoNavia® must be operated together with ultrasound imaging guidance. The components of the system are designed to operate safely when used together for the diagnostic sampling as referred to in this manual.

3.5.1 Component description

- The **base unit** supplies NeoNavia® with power.
- The **driver** is attached to the base unit and controls the operation of NeoNavia® during the procedure. The base unit and the driver are non-sterile.
- The **probes** are attached to the driver. The sampling needle on the probes is the Applied Part. This means that the sampling needle is the part that comes into physical contact with the patient in order for the NeoNavia® biopsy system to perform its function. The probes are delivered sterile and intended for single-use only.

3.5.2 Pulse Technology description

Pulse Technology enables a safe and user controlled insertion and positioning of the sampling needle. The pneumatic driver, powered by the base unit, enables a short and distinct stepwise progression of the needle. This facilitates ease of access and flexibility in sampling even in very small lesions in delicate and difficult locations. The pulses are completely user controlled through the pulse button on the driver.

4 Installation

4.1 Site requirements

- NeoNavia® must only be used in hospitals or healthcare facilities.
- NeoNavia® must have access to electrical power, see 9.3.
- NeoNavia® must only be operated, transported or stored as shown in the specified environmental conditions in the table below.

Parameter	Approved range
Temperature, operation	15°C to 30°C (59°F to 86°F)
Temperature, transport	-20°C to 60°C (-4°F to 140°F)
Temperature, storage	10°C to 40°C (50°F to 104°F)
Relative humidity, operation	30 % to 75 % RH
Relative humidity, storage and transport	10 % to 90 % RH
Atmospheric pressure, operation	80 kPa to 106 kPa (11.6 psi to 15.4 psi)
Atmospheric pressure, storage and transport	60 kPa to 106 kPa (8.7 psi to 15.4 psi)

4.2 Power requirements

NeoNavia® must be connected to a supply mains with protective earth when it is operated. The operation voltage must be 110-120 VAC / 60 Hz. For more information about electrical requirements, see 9.3.

4.3 To install NeoNavia biopsy system

This instruction contains information about the installation of NeoNavia®.



Warning: Only connect NeoNavia® to a supply mains with protective earth. Risk of electrical shock.



Warning: Do not use a multiple socket-outlet or an extension cord.



Caution: Do not use NeoNavia® when the power cord is wound around the cover, handle or any other part of the base unit.

4.3.1 To install the driver

1.

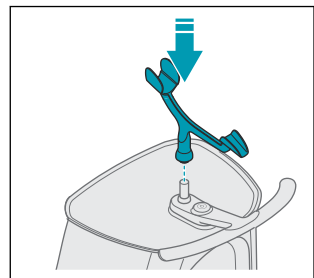

2.

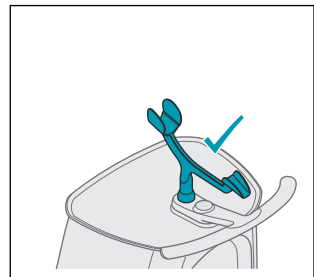

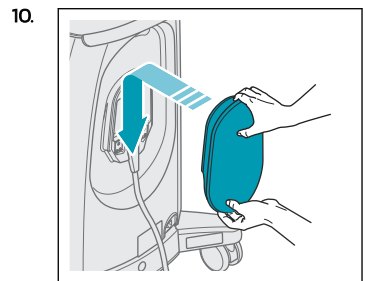
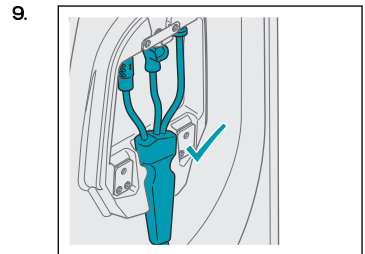
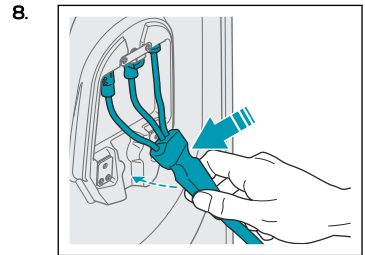
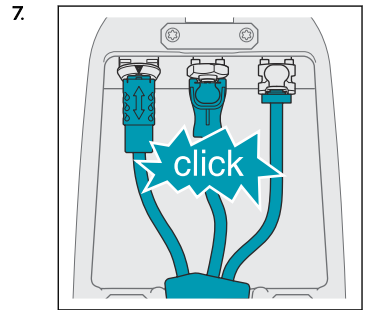
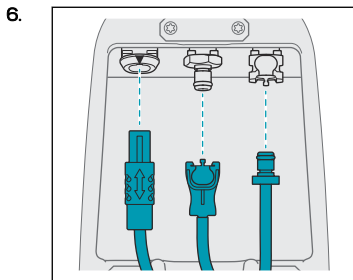
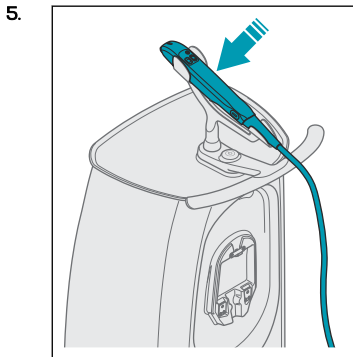
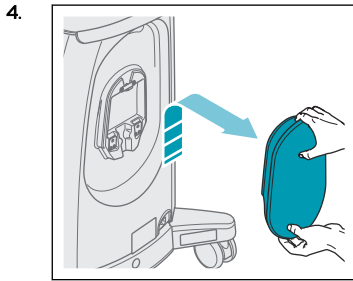
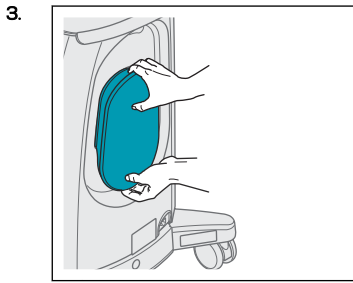

4.3.2 To move and park NeoNavia®



Caution: Floors should be wood, concrete or ceramic tile. If floors are covered with synthetic material, see [9.4.2](#) for more information.

1.

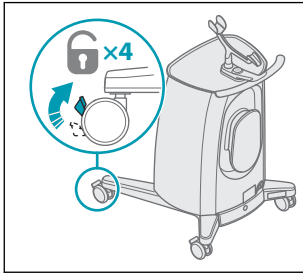

2.

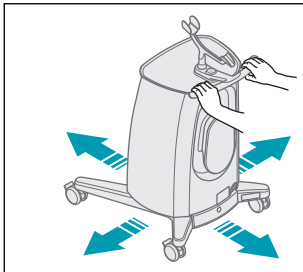

Warning: Make sure that the driver cable is secure when moving NeoNavia®. A loose cable can trip the operator.

3.

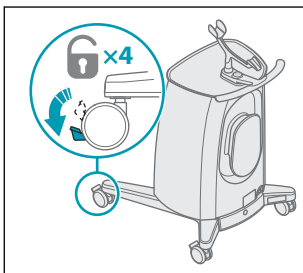

4.3.3 To connect NeoNavia to the wall socket



Caution: Make sure not to block the access to the appliance inlet. It must be possible to remove the power cord from the appliance inlet to make sure that NeoNavia® is without power.

1.

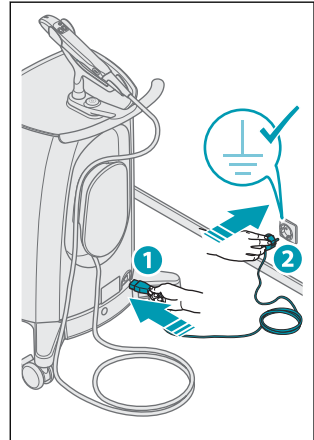

2.

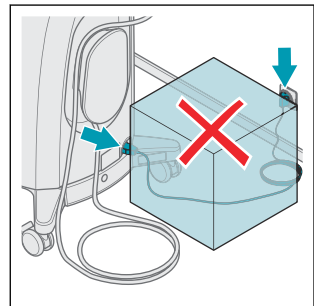

Notice: NeoNavia® will go into stand-by mode if it is not used for 10 minutes. Start NeoNavia®, see chapter [5.2.2](#).

5 Operation

5.1 To prepare for biopsy

5.1.1 To unpack the probe



Warning: Make sure that the sterile packaging is not damaged.



Warning: Do not remove the protective sleeve from the sampling needle.



Warning: Do not bend the sampling needle. If the sampling needle is bent, do not use the probe.

1.

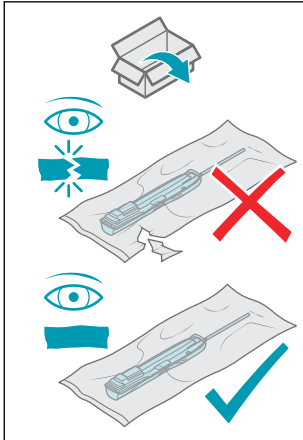

2.

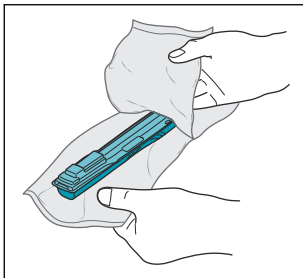

3.

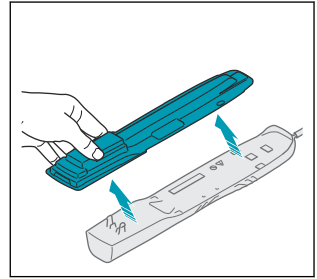

4.

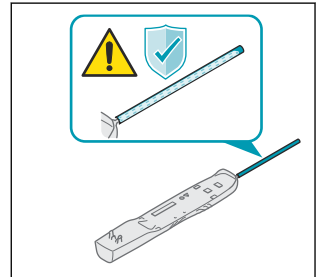

Caution: Do not manually manipulate the probe before attaching it to the driver. The probe might become unusable.

5.1.2 To attach the probe

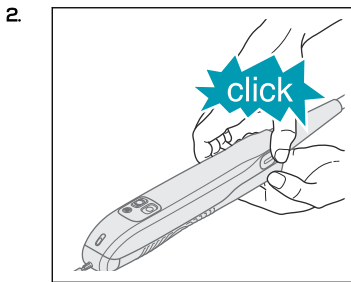
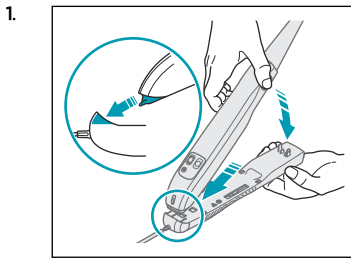

Warning: Use ultrasound guidance when you operate NeoNavia® biopsy system, to visualize the movements of the device. Do not use MRI or stereotactic guidance.



Warning: Do not use NeoNavia® biopsy probes more than once. They are intended for single patient use only. If components that are intended for single patient use only are used again, it can result in infection or injury of the patient.



Warning: Do not use a damaged probe. If the sampling needle is bent, do not use the probe.



Caution: Do not use NeoNavia® when the power cord is wound around the cover, handle or any other part of the base unit.



Caution: Make sure that the driver cable is free from external pressure. Objects or persons standing on the cable may lead to reduced performance and damage to the cable.



Notice: Take special care when the sampling site is close to a biopsy site marker clip or other implanted devices.

5.1.3 To prepare the sampling area

1. Use standard technique and follow local guidelines to disinfect and anesthetize relevant areas.
2. Use a scalpel to make a small incision.

5.2 To perform a biopsy



Warning: Use applicable personal protective equipment following local guidelines (for example gloves), during operation and maintenance of NeoNavia® biopsy system, to prevent exposure to biohazards.

5.2.1 The buttons on the driver

The pulse button

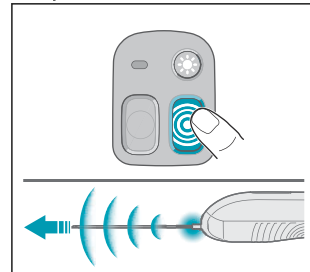

The pulse button moves the needle forward in short steps. Use if

manual penetration of the tissue is problematic.

The sampling button

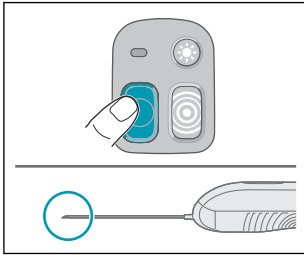

The sampling button is used to take the biopsy samples. The functionality of the button varies depending on the probe that is connected to the driver and, for some probes, on how long the button is pressed.

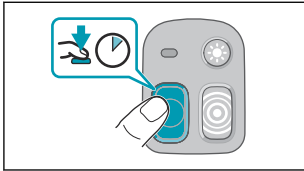

A long press on the sampling button is longer than 1.5 second. In the manual this image is used to show when a long press is needed.

The light button

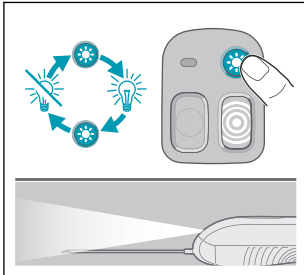

The light button activates and deactivates the light.

The Driver status indicator

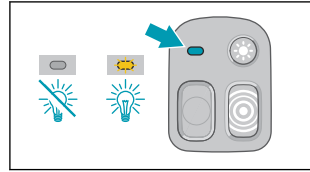

The driver status indicator is automated and not directly controlled by the user. It indicates the different states of the probes in the sampling processes with a steady light. The driver status indicator flashes when something is wrong with the driver or the attached probe. See [72](#)

5.2.2 To start the base unit

1.

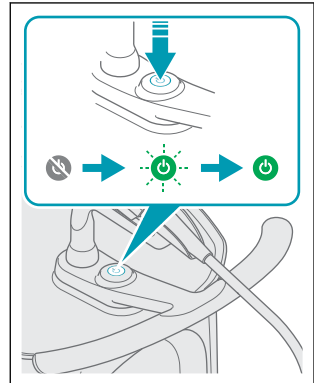

Notice: A system self-test is performed every time NeoNavia® starts up. If the system self-test is successful the On/Off button turns green, if the system self-test is not successful the On/Off button turns red. If the On/Off button turns red, see [71](#).

5.2.3 To use the FlexiPulse probe

1.

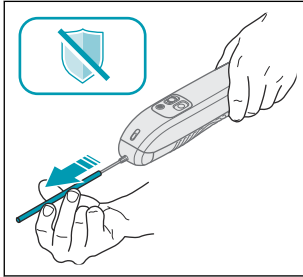

2. Insert the needle and pulse towards the suspicious lesion, using short taps of the pulse button.

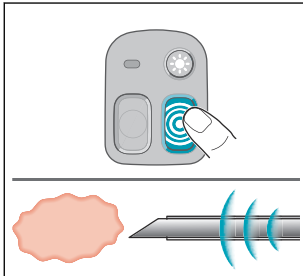

3.

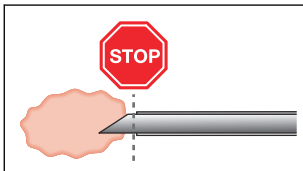

4. Tap the sampling button to retract the trocar and expose the open tip of the edge of the suspicious lesion.

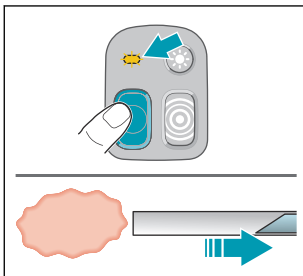

Notice: Light on indicates that the needle is in sampling mode.

5. Use the pulse button to advance through the lesion filling the sample chamber as you advance.

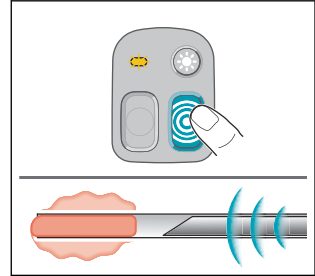

6. Tap the sampling button to cut the sample.

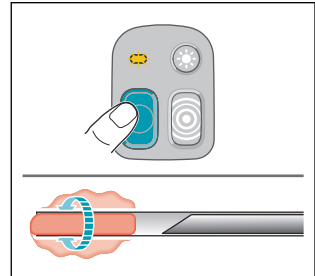

7. Press and hold the sampling button to eject the sample.

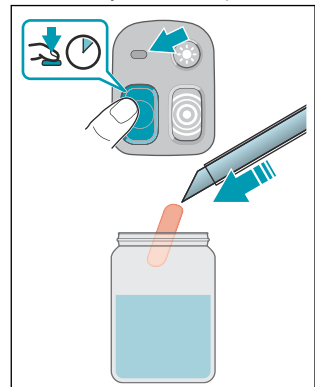

8.

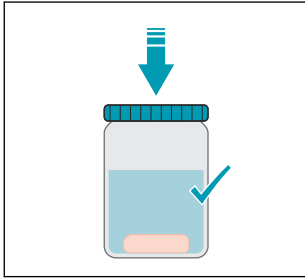

Notice: Blood in the transparent vacuum chamber indicates bleeding at the sample site.

9. Repeat from step 2 to collect more samples.

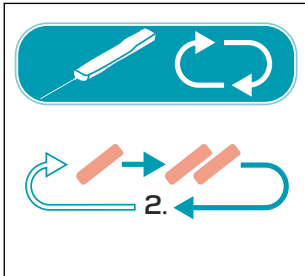

Notice: The FlexiPulse probe is tested up to 30 sampling cycles without any signs of degradation.

5.2.4 To use the VacuPulse probe - automatic mode

1.

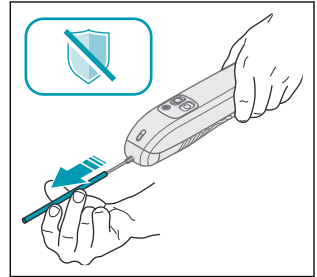

2. Insert the needle and pulse into the suspicious lesion, using short taps of the pulse button.

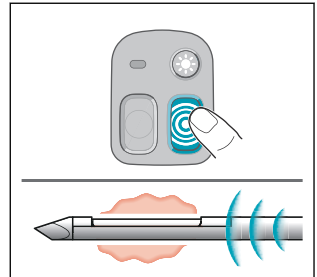

3. Tap the sampling button to take the sample. The sequence is completely automatic.

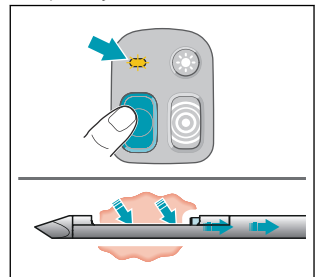

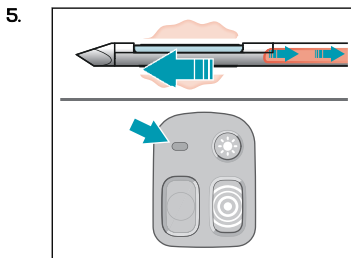
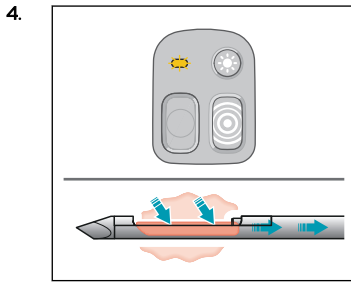

6. Repeat from step 3 to collect more samples.

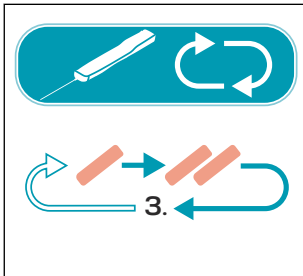

i **Notice:** The VacuPulse probe is tested up to 30 sampling cycles without any signs of degradation.

7. Samples are collected in the transparent tissue basket.

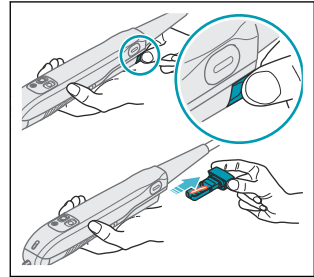

i **Notice:** Blood in the transparent vacuum chamber indicates bleeding at the sample site.

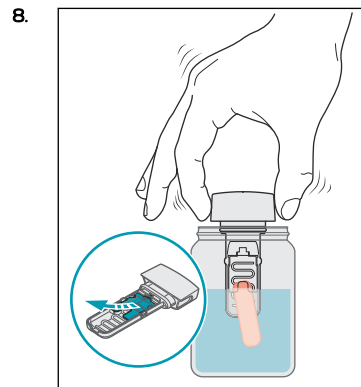

i **Notice:** The lid on the tissue basket can be removed if necessary.

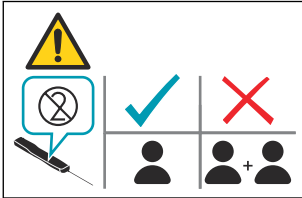
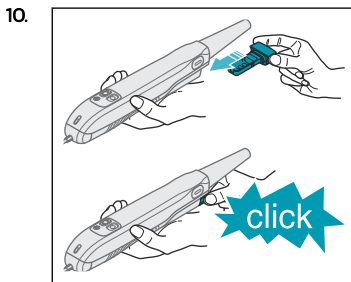
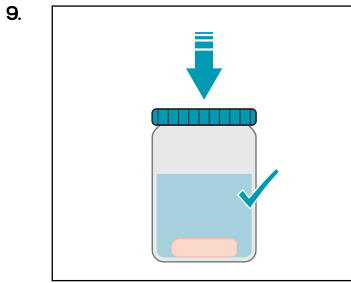

5.2.5 To use the VacuPulse probe – manual mode

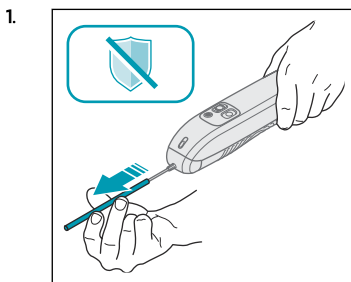

2. Insert the needle and pulse into the suspicious lesion, using short

taps of the pulse button.

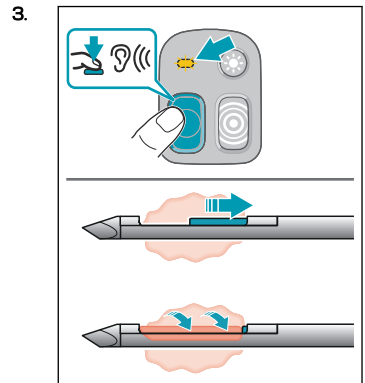
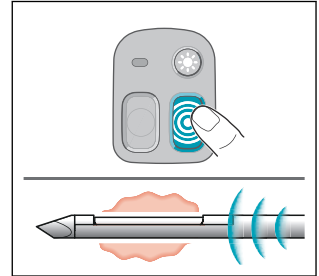

Notice: The needle is now open and the vacuum is on. Adjust the position of the needle manually as needed.

4. Press the sampling button to take the sample.

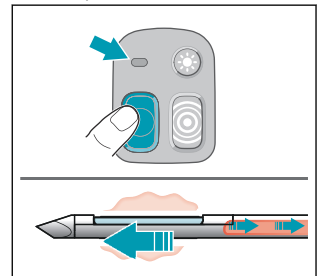

5. Repeat from step 3 to collect more samples.

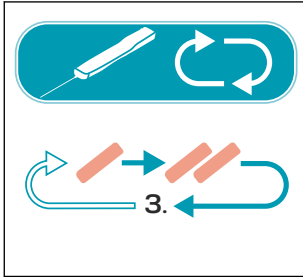

Notice: The VacuPulse probe is tested up to 30 sampling cycles without any signs of degradation.

6. Samples are collected in the transparent tissue basket.

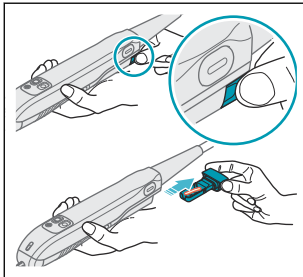

Notice: Blood in the transparent vacuum chamber indicates bleeding at the sample site.

- 7.

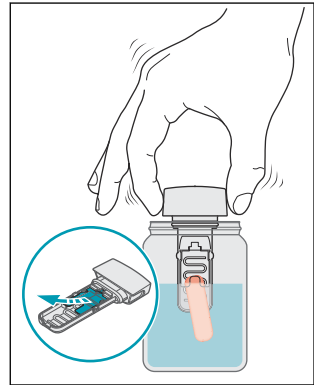

Notice: The lid on the tissue basket can be removed if necessary.

- 8.

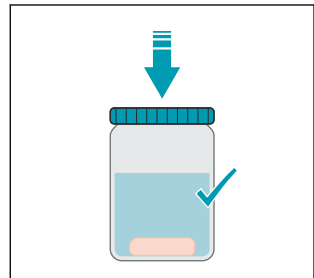

- 9.

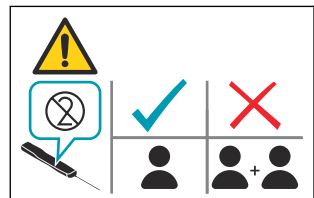
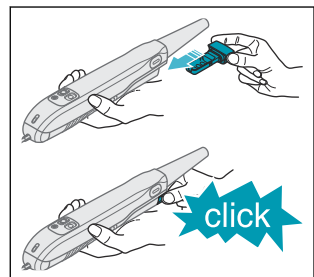

5.3 To turn off the NeoNavia® biopsy system and dispose of the probe after biopsy



Warning: Use applicable personal protective equipment following local guidelines (for example gloves), during operation and maintenance of NeoNavia®, to prevent exposure to biohazards.

1.

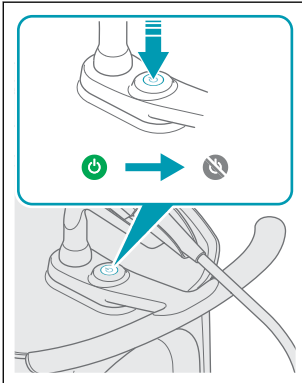

Notice: When NeoNavia® is turned off, a fan will continue to run. This ventilates the base unit to avoid excess heating.

2.

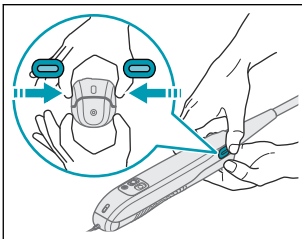

3.

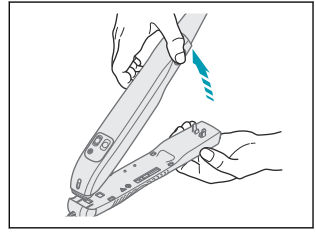

4. Discard the probe as referred to in local laws and regulations.



Notice: The On/Off button puts NeoNavia® into stand-by mode. To disconnect NeoNavia® completely, remove the power cord from the appliance inlet.

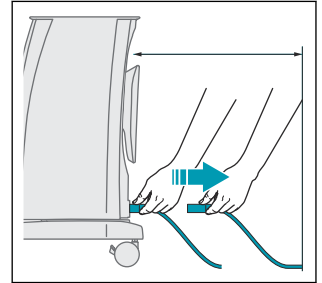

6 Maintenance

6.1 To clean and inspect

6.1.1 To clean and inspect the base unit

Clean the NeoNavia® biopsy system and visually inspect it for damage after each procedure or as required.



Warning: Do not submerge or spray liquids directly on any parts of the NeoNavia® biopsy system.

1. Disconnect the power cord.

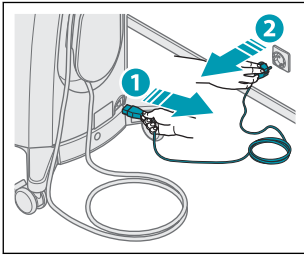

2. Do a visual check for damages and contamination.

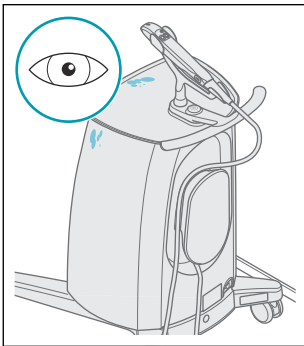

Notice: If damage to the NeoNavia® biopsy system is discovered during the inspection, please contact a NeoDynamics representative. See chapter 1.5 for contact information.

3. Clean all the relevant exterior surfaces with a soft clean cloth that is lightly moisturised with a cleaning solution. Make sure that no contamination remains.

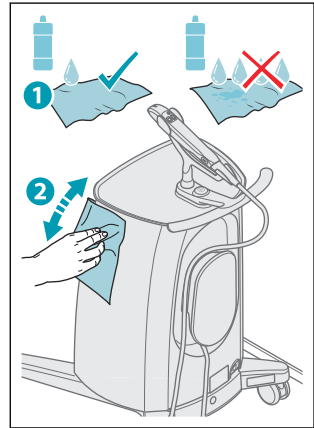

Notice: The cleaning solution should be soap and water, pH neutral or pH neutral enzymatic detergent or alcohol (ethanol or isopropyl alcohol) based cleaning solution.

4. Wipe the base unit with a soft clean cloth that is lightly moisturised with tap water.

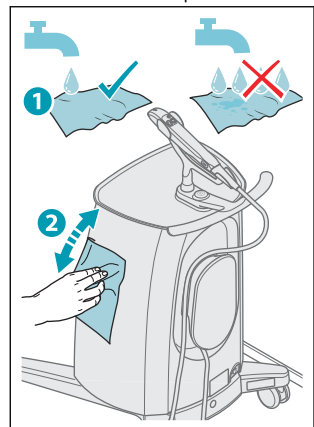

5. Wipe the base unit dry with a soft clean cloth.

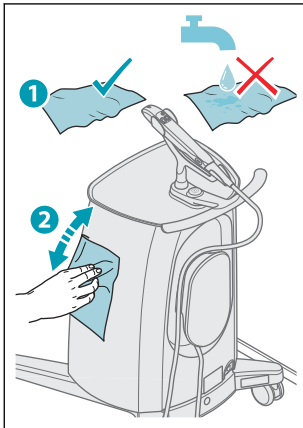

6. Do a visual check for contamination. If contamination remains, repeat step 3 to 5. Make sure not to use a visually soiled device, please contact a NeoDynamics representative for direction. See chapter 1.5 for contact information.

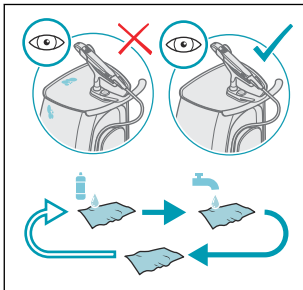

1. Do a visual check for damages and contamination.

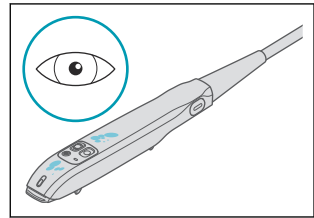

2. Clean all the surfaces exposed during the sampling procedure (probe attached). Use a soft clean cloth that is lightly moisturised with a cleaning solution. Make sure that no contamination remains. Use a small soft brush like a toothbrush as needed.

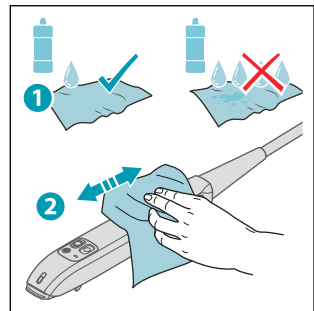

Notice: The cleaning solution should be soap and water, pH neutral or pH neutral enzymatic detergent or alcohol (ethanol or isopropyl alcohol) based cleaning solution.

6.1.2 To clean and inspect the driver

Clean the NeoNavia® biopsy system and visually inspect it for damage after each procedure or as required.



Warning: Do not submerge or spray liquids directly on any parts of the NeoNavia® biopsy system.

- Wipe the driver with a soft clean cloth that is lightly moisturised with tap water.

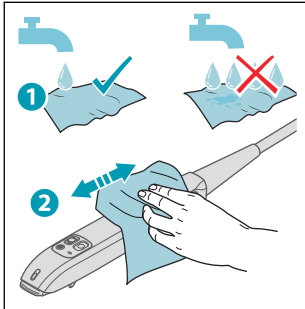

- Wipe the driver dry with a soft clean cloth.

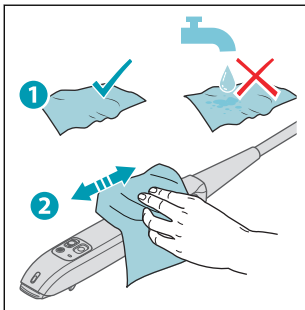

- Disinfect all the surfaces exposed during the sampling procedure (probe attached). Use a soft clean cloth lightly moisturised with a detergent based disinfectant, ethanol 96 % or isopropyl alcohol. Make sure that all the crevices are disinfected. Use a small soft brush like a toothbrush as needed.

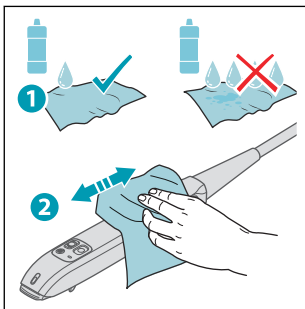

- Let the driver air-dry.
- Do a visual check for contamination. If contamination remains, repeat step 2 to 6. Make sure not to use a visually soiled device, please contact a NeoDynamics representative for direction. See chapter 1.5 for contact information.

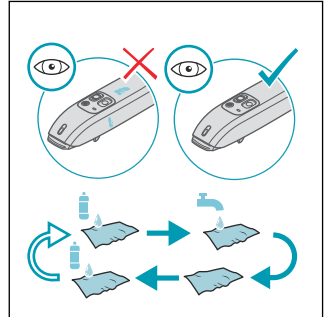

6.2 To do an electrical safety test



Notice: There is a ground connection on the base unit. See chapter 3.2

- Inspect all cables and connectors for possible wear or damage.



Notice: If damage to the NeoNavia® biopsy system is discovered during the inspection, please contact a NeoDynamics representative. See chapter 1.5 for contact information.

- Electrical safety testing should be performed at intervals no greater than 12 months, using a standard medical safety analyzer. Please contact NeoDynamics if you need additional information on how to perform the electrical safety testing.

6.3 To maintain the driver

1. Keep a record of when the current driver was installed.
2. Replace the driver after 3 years or 1000 procedures, whichever comes first.



Notice: The customer should contact NeoDynamics if wear or damage is detected within three years or 1000 procedures. Then service or replacement will be required.

7 Troubleshooting



Notice: Please report product related problems to NeoDynamics AB. See chapter 15 for contact information.

7.1 To troubleshoot NeoNavia® biopsy system

<p>The base unit On/Off button status indicator does not light up when I press the On/Off button.</p>	
	<p>Possible cause: NeoNavia® is not powered.</p>
<p>1.</p> <p>2.</p> <p>3.</p>	<p>Corrective action:</p> <ol style="list-style-type: none"> 1. Make sure that the wall outlet is powered. 2. Make sure that the power cord is connected to the base unit and plugged into the wall outlet. 3. Press the On/Off button until NeoNavia® is turned on. See chapter 5.22.

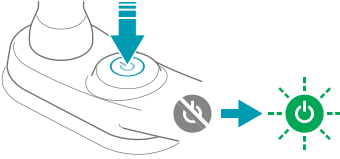
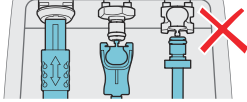
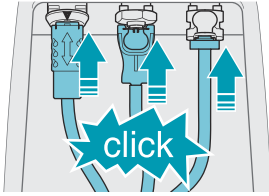
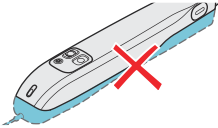
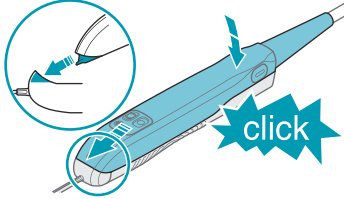
The base unit On/Off button status indicator is flashing green.	
	
	<p>Possible cause: The driver is not properly connected.</p>
	<p>Corrective action: Make sure that the driver is properly connected. See chapter 4.3.1.</p>
	<p>Possible cause: There is no probe attached to the driver.</p>
	<p>Corrective action: Connect the selected probe. See chapter 5.1.2.</p>

The base unit On/Off button status indicator is flashing green.



Possible cause:

The system self test has reported an issue that might have some effect on sampling performance but with no effect on system safety.

1.

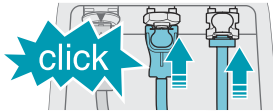

2.

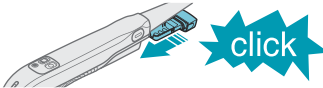

3.



Corrective action:

1. Make sure that the pressurized air connection and vacuum connection are properly connected. See chapter 4.3.1.
2. The system is safe to use. If the issue remains, please contact a NeoDynamics representative. See chapter 1.5 for contact information.

The base unit On/Off button status indicator is green but pulses are not activated when the pulse button is pressed.

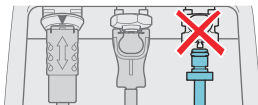
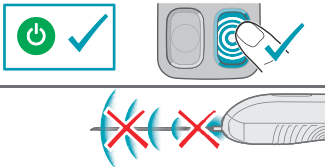







Possible cause:

The pressurized air connector to the driver is not properly connected.



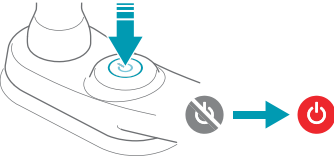





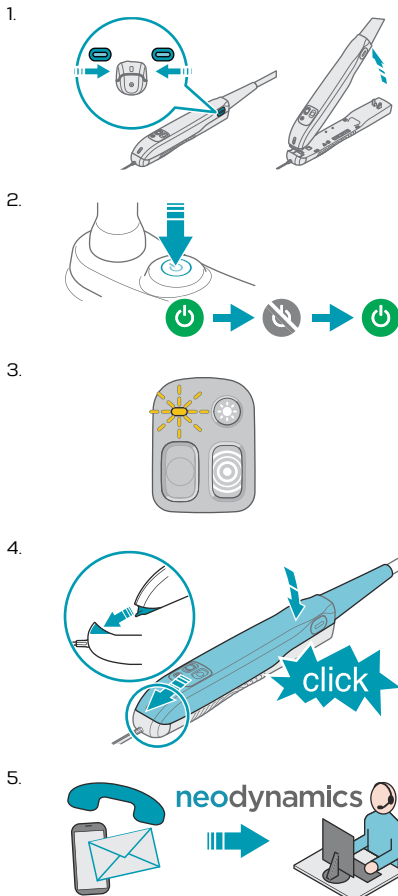

Corrective action:

Make sure the pressurized air connection is properly connected. See chapter 4.3.1.

The base unit On/Off button status indicator is green but pulses are not activated when the pulse button is pressed.	
	Possible cause: NeoNavia® biopsy system is not working properly.
	Corrective action: Contact a NeoDynamics representative. See chapter 1.5 for contact information.
The base unit On/Off button status indicator is red.	
	
	Possible cause: The system is starting up.
	Corrective action: 1. Wait 5 seconds. 2. Make sure that the status indicator turns green.
	Possible cause: If the driver status indicator is flashing yellow – this indicates a driver error.

The base unit On/Off button status indicator is red.**Corrective action:**



1. Remove the probe.
2. Restart the system.
3. If the driver status indicator is flashing yellow, follow the instructions for The yellow status indicator flashes yellow, no probe is attached. See [5.2.2](#).
4. Attach a new probe.
5. If the issue remains, please contact a NeoDynamics representative. See [chapter 15](#) for contact information.

The base unit On/Off button status indicator is red.	
	<p>Possible cause: The system self test has reported a safety related issue. NeoNavia® is in fail safe with only the status indicator lit.</p>
<p>1. </p> <p>2. </p> <p>3. </p> <p>4. </p> <p>5. </p>	<p>Corrective action:</p> <ol style="list-style-type: none"> 1. Remove the power cord from the wall outlet. 2. Wait for 20 minutes. 3. Reconnect the power cord to the wall outlet. 4. Try to restart the NeoNavia® biopsy system. 5. If the issue remains, please contact a NeoDynamics representative. See chapter 1.5 for contact information.
The base unit On/Off button status indicator is not lit, but NeoNavia® is turned on (indicated by sound).	
	
	<p>Possible cause: The status indicator does not work.</p>
	<p>Corrective action: Contact a NeoDynamics representative. See chapter 1.5 for contact information.</p>

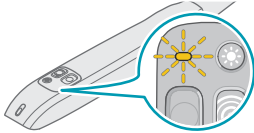
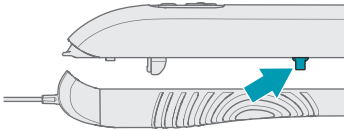
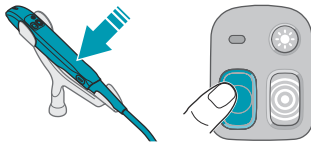
7.2 To troubleshoot the driver

The yellow status indicator flashes yellow, no probe is attached.	
	
	<p>Possible cause: The driver is not in its most forward position.</p>
	<p>Corrective action:</p> <ol style="list-style-type: none"> 1. Position the driver safely in the base unit holder. 2. Press the sampling button to reset the driver to home position.

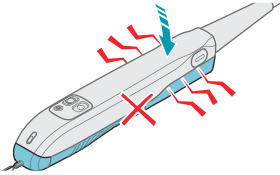
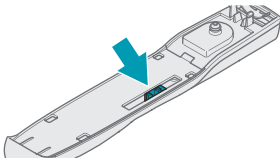
7.3 To troubleshoot the probe

It is not possible to attach the probe to the driver.	
	
	<p>Possible cause: The sledge of the probe is not in its most forward position, either due to manual manipulation or that the probe has been released from the driver during a sampling sequence.</p>
	<p>Corrective action: Dispose of the probe per instruction and select a new probe to continue the procedure.</p>

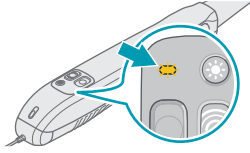
The driver status indicator is yellow.

This is not an error but an indication that the probe is loaded/open for sampling.



FlexiPulse: from the time the sampling button is pressed until the sequence is complete.

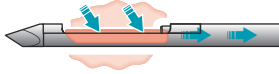

VacuPulse: from the time the tip is pulled back until the sample is ejected.

8 Recycling

8.1 To recycle the NeoNavia® biopsy system

Follow the instructions below when you take NeoNavia® out of service for decommission or disposal:

1. Make sure that base unit and driver is cleaned as referred to in chapter [6.1.1](#).
2. Do not discard the base unit or driver. It should be returned to the manufacturer. See chapter [1.5](#) for contact information.
3. The FlexiPulse and VacuPulse probes must be disconnected and disposed of in accordance with national and local environmental regulations covering medical waste and packaging material.

9 Technical data

9.1 Conformity

Directive or standard	Title
ANSI AAMI ES60601-1:2005/(R)2012 and A1:2012, C1:2009/(R)2012 and A2:2010/(R)2012	Medical electrical equipment - Part 1: General requirements for basic safety and essential performance

9.2 Weight and dimensions

Configuration	Weight	Width	Depth	Height
Base unit ¹	55 kg / 121.3 lb	53 cm / 20.9 in	61 cm / 24 in	81 cm / 31.9 in
Driver ²	0.7 kg / 1.5 lb	4.5 cm / 1.8 in	25.5 cm / 10 in	3.7 cm / 1.5 in

9.3 Electrical specifications

Parameter	Value
Standard	EN 60601-1:2006/A1:2013
Classification	Class I Type BF Continuous operation
Operation voltage	110-120 VAC / 60 Hz
Rated power (A)	4.3 A
Mains fuse rating	T 10 AH, 250 V
Power cord length	3 m / 9.8 ft

9.4 Electromagnetic compatibility (EMC)



Warning: Do not use the NeoNavia® biopsy system near active HF surgical equipment or the RF shielded room of a system for magnetic resonance imaging (MRI).

9.4.1 Electromagnetic emissions – guidance and manufacturer's declaration

Medical Electrical Equipment needs special precautions regarding EMC and needs to be installed and put into service according to the EMC information provided below. NeoNavia® is intended for use in the electromagnetic environment specified below. The customer or the user of NeoNavia® should assure that it is used in an environment that complies with the specifications. Portable and Mobile RF Communications Equipment can affect Medical Electrical Equipment. The essential performance of the NeoNavia® is that the needle shall not move unless intentionally activated. This has been the criterium for all EMC compliance testing.

¹ The weight is the total weight of the NeoNavia biopsy system, including the maximum load of 15 kg/121.3 lb.

² The cable is not included in the weight or in the dimensions.

Table 1: Guidance and Manufacturer's Declaration – Electromagnetic emissions

Emission test	Compliance	Electromagnetic environment - guidance
RF emission CISPR 11	Group 1	NeoNavia® uses RF energy only for its internal function. Therefore, RF emissions are very low and are not likely to cause any interference in nearby electronic equipment.
RF emission CISPR 11	Class B	RF emission CISPR 11 class B compliance covers HOME HEALTHCARE ENVIRONMENT. This makes NeoNavia® biopsy system suitable for use in all establishments, including domestic establishments and those directly connected to the public low-voltage power supply network that supplies buildings used for domestic purposes.
Harmonic emission IEC 61000-3-2	Class A	
Voltage fluctuations / flicker emissions IEC 61000-3-3	Complies ($P_{st} \leq 1.0$, $P_{it} \leq 0.65$, $T_{max} \leq 500$ ms, $d_c \leq 3.3$ %, $D_{max} \leq 7$ %)	

9.4.2 Electromagnetic immunity – guidance and manufacturer's declaration

NeoNavia® is intended for use in the electromagnetic environment specified in the next section. The customer or the user of the NeoNavia® should assure that it is used in an environment that complies with the specifications.



Warning: Use of the NeoNavia® biopsy system adjacent to or stacked with other equipment, for example ultrasound equipment, should be avoided. It can result in improper operation. If such use is necessary, the NeoNavia® biopsy system and the other equipment should be observed to verify that they are operating normally.

Table 2: Guidance and Manufacturer's Declaration – Electromagnetic Immunity for all ME equipment and ME systems

Immunity test	EN/IEC 60601 Test Level	Compliance level	Electromagnetic environment - guidance
Electrostatic discharge (ESD) IEC 61000-4-2	± 8 kV contact, ± 2 , ± 4 , ± 8 , ± 15 kV air discharge	± 8 kV contact, ± 2 , ± 4 , ± 8 , ± 15 kV air discharge	Floors should be wood, concrete or ceramic tile. If floors are covered with synthetic material, the relative humidity should be at least 30 %.
Electrical fast transient/burst IEC 61000-4-4	± 2 kV for power supply lines ± 1 kV for input/output lines	± 2 kV for power supply lines ± 1 kV for input/output lines	Mains power quality should be that of a typical commercial or hospital environment.

Immunity test	EN/IEC 60601 Test Level	Compliance level	Electromagnetic environment – guidance
Surge IEC 61000-4-5	$\pm 0,5$ kV, ± 1 kV line(s) to line(s) $\pm 0,5$ kV, ± 1 kV ± 2 kV line(s) to earth	$\pm 0,5$ kV, ± 1 kV line(s) to line(s) $\pm 0,5$ kV, ± 1 kV ± 2 kV line(s) to earth	Mains power quality should be that of a typical commercial or hospital environment.
Voltage dips, short interruptions and voltage variations on power supply input lines IEC 61000-4-11	$< 0\%$ U_T (100 % dip) for 0.5 cycles @ sine angles: 0, 45, 90, 135, 180, 225 & 270 degrees. 0% U_T (100 % dip) for 1 cycle. 70% UT (30 % dip) for 25 cycles. 0% U_T (100 % interruption) for 250 cycles.	$< 0\%$ U_T (100 % dip) for 0.5 cycles @ sine angles: 0, 45, 90, 135, 180, 225 & 270 degrees. 0% U_T (100 % dip) for 1 cycle. 70% UT (30 % dip) for 25 cycles. 0% U_T (100 % interruption) for 250 cycles.	Mains power quality should be that of a typical commercial or hospital environment.
Power frequency (50/60 Hz) magnetic field IEC 61000-4-8	30 A/m	30 A/m	Power frequency magnetic fields should be at levels characteristic of a typical location in a typical commercial or hospital environment.



Notice: U_T is the AC mains voltage prior to application of the test level.

NeoNavia® is intended for use in the electromagnetic environment specified below. The customer or the user of NeoNavia® should make sure that it is used in an environment that complies with the specifications.

Table 3: Guidance and Manufacturer’s Declaration – Electromagnetic Immunity for all ME equipment and ME systems that are not life-supporting

Immunity test	EN/IEC 60601 Test Level	Compliance level	Electromagnetic environment – guidance
Conducted RF IEC 61000-4-6	3 Vrms 150 kHz to 80 MHz (6 Vrms for ISM & amateur radio bands between 150 kHz to 80 MHz)	3 Vrms 150 kHz to 80 MHz (6 Vrms for ISM & amateur radio bands between 150 kHz to 80 MHz)	N/A
Radiated RF IEC 61000-4-3	10 V/m 80 MHz to 2.7 GHz	10 V/m 80 MHz to 2.7 GHz	Recommended separation distance: $d =$ minimum 30 cm.



Warning: Portable and mobile RF communication equipment (including peripherals such as antenna cables and external antennas) should not be used closer than 30 cm to any part of the NeoNavia® biopsy system, including cables specified by the manufacturer. Otherwise, degradation of the performance of this equipment could result.



Notice: These guidelines may not apply in all situations. Electromagnetic propagation is affected by absorption and reflections from structures, objects and people.

Table 4: Guidance and Manufacturer's Declaration – Electromagnetic Immunity to proximity fields from RF wireless communications equipment, compliance levels per EN/IEC 60601

Test frequency	Band	Service/Application	Modulation	Maximum power (W)	Distance (m)	Immunity test Level
385 MHz	380 – 390	• TETRA 400	Pulse modulation 18 Hz	1.8	0.3	27 V/m
450 MHz	430 – 470	• GMRS 460 • FRS 460	FM ± 5 kHz deviation 1 kHz sine	2	0.3	28 V/m
710 MHz	704 – 787	• LTE band 13 & 17	Pulse modulation 217 Hz	0.2	0.3	9 V/m
745 MHz						
780 MHz						
810 MHz	800 – 960	• GSM 800/900 • TETRA 800 • iDEN 820 • CDMA 850 • LTE band 5	Pulse modulation 18 Hz	2	0.3	28 V/m
870 MHz						
930 MHz						
1720 MHz	1700 – 1990	• GSM 1800 • CDMA 1900 • GSM 1900 • DECT, LTE band 13 4 & 25, UMTS	Pulse modulation 217 Hz	2	0.3	28 V/m
1845 MHz						
1970 MHz						
2450 MHz	2400 – 2570	• Bluetooth • WLAN 802.11 b/g/n • RFID 2450 • LTE band 7	Pulse modulation 217 Hz	2	0.3	28 V/m
5240 MHz	5100 – 5800	• WLAN 802.11 a/n	Pulse modulation 217 Hz	0.2	0.3	9 V/m
5500 MHz						
5785 MHz						

Table 5: Guidance and Manufacturer's Declaration – Electromagnetic Immunity to proximity fields from RF wireless communications equipment (additional compliance levels)

Test frequency	Band	Service/Application	Modulation	Maximum power (W)	Distance (m)	Immunity test Level
400 MHz	400 – 470	TETRA	Pulse modulation 18 Hz	1.8	0.3	27 V/m
423 MHz						

Test frequency	Band	Service/Application	Modulation	Maximum power (W)	Distance (m)	Immunity test Level
446 MHz						
470 MHz						
910 MHz	800 – 960	Z-wave	Pulse modulation 18 Hz	2	0.3	28 V/m
800 MHz	N/A	LTE band 8, 20 & 40	Pulse modulation 217 Hz	2	0.3	28 V/m
900 MHz						
2300 MHz						
30 kHz	N/A	Induction cooking appliances and ovens	CW	N/A	N/A	8 A/m
134.2 kHz	N/A	RFID / Electronic Article Surveillance (EAS)	Pulse-modulated, duty cycle 50 %, 2.1 kHz repetition rate	N/A	N/A	65 A/m
13.56 MHz	N/A	RFID	Pulse-modulated, duty cycle 50 %, 100 kHz repetition rate	N/A	N/A	12 A/m
433 MHz	N/A	RFID	Pulse modulation 217 Hz	0.02	0.3	3 V/m
810 MHz	N/A	RFID	Pulse modulation 217 Hz	7.3	0.3	54 V/m
910 MHz	N/A	RFID	Pulse modulation 217 Hz	7.3	0.3	54 V/m
960 MHz	N/A	RFID	Pulse modulation 217 Hz	7.3	0.3	54 V/m
2450 MHz	N/A	RFID	Pulse modulation 217 Hz	7.3	0.3	54 V/m

10 Consumables

Ref#	Article name
2104	FlexiPulse (14G)
2102	VacuPulse (10G)
3103	Tissue basket for VacuPulse

for more information

NeoDynamics AB
Lejonvägen 14
SE-181 32 Lidingö
Sweden

www.neodynamics.com



neodynamics